

## Description

- Micro computer circuits in mobile phones, word processors, TVs, VCRs etc
- General logic circuits
- Detection of voltage drop in batteries of note personal computers, mobile phones
- Switching to backup power supply

## Features

- Super Low Current Consumption ( $I_{CCL}=100\ \mu A$  Typ.  $I_{CCH}=1\ \mu A$  Typ.)
- It has on delay function to supplement the constant of outer C and R
- Low operation voltage
- High current of output transistor
- Hysteresis circuit built in
- Low operation voltage

## Ordering Information

Type NO.	Marking	Package Code
S71xxLSF	L	SOT-23F

: Detecting Voltage Code

## Outline Dimensions

unit : mm

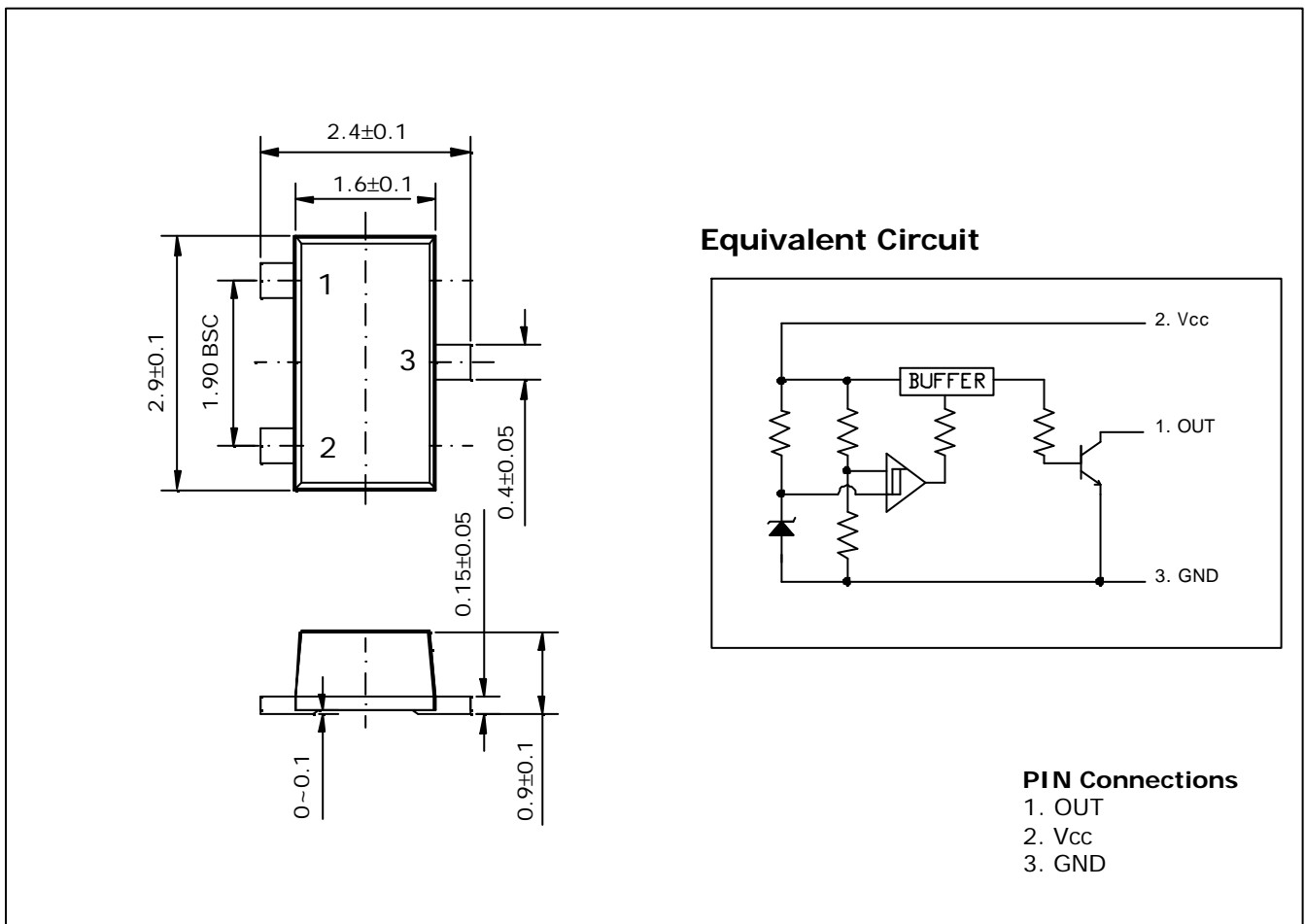

## Absolute maximum ratings

(Ta=25°C)

Characteristic	Symbol	Ratings	Unit
Supply voltage	V <sub>CC</sub>	-0.3 ~ +10	V
Power Dissipation (Package Limitation)	P <sub>D</sub> *	300	mW
Operating Temperature	T <sub>opr</sub>	-20 ~ +75	
Storage Temperature	T <sub>stg</sub>	-40 ~ +125	

\* With PCB(8 x8 mm Copper Area) at Glass Epoxy Board (t=1.7 mm, Area; 20 x20 mm)

## Electrical Characteristics

(Ta=25°C)

Characteristic	Symbol	Test Circuit	Test Condition	Min.	Typ.	Max.	Unit	
Detecting voltage	V <sub>S</sub>	1	R <sub>L</sub> =470 V <sub>CC</sub> =H L V <sub>OL</sub> 0.4V	S7145LSF	4.30	4.5	4.70	V
				S7142LSF	4.00	4.2	4.40	
				S7139LSF	3.70	3.9	4.10	
				S7136LSF	3.40	3.6	3.80	
				S7133LSF	3.10	3.3	3.50	
				S7131LSF	2.90	3.1	3.30	
				S7129LSF	2.75	2.9	3.05	
				S7127LSF	2.55	2.7	2.85	
				S7125LSF	2.35	2.5	2.65	
				S7123LSF	2.15	2.3	2.45	
Hysteresis Voltage	V <sub>S</sub>	1	R <sub>L</sub> =470 , V <sub>CC</sub> =L H L	30	100	300	mV	
Temperature Coefficient Of detecting voltage	V <sub>S</sub> / T	1	R <sub>L</sub> =470 , Ta=-20~75	-	±0.01	-	%/	
Low Level Output voltage	V <sub>OL</sub>	1	R <sub>L</sub> =470 , V <sub>CC</sub> = V <sub>SMin</sub>	-	0.1	0.4	V	
Circuit current at ON	I <sub>CCL</sub>	1	R <sub>L</sub> = , V <sub>CC</sub> = V <sub>SMin</sub>	-	300	500	μA	
Circuit current at OFF	I <sub>CCH</sub>	1	R <sub>L</sub> = , V <sub>CC</sub> = V <sub>SMax</sub> +0.1V	-	30	50	μA	
Threshold Operating Voltage	V <sub>opr</sub>	1	R <sub>L</sub> =4.7 kΩ, V <sub>OL</sub> 0.4V	-	1.4	1.6	V	
Output Current at ON I	I <sub>OLI</sub>	1	R <sub>L</sub> =0, V <sub>CC</sub> = V <sub>SMin</sub>	10	20	-	mA	
Output Current at ON II	I <sub>OLII</sub>	1	R <sub>L</sub> =0, V <sub>CC</sub> = V <sub>SMin</sub> , Ta= -20~75	5	-	-	mA	
L H Transmission delay time	t <sub>PLH</sub>	2	R <sub>L</sub> =4.7 kΩ, C <sub>L</sub> =100 pF	-	100	-	μs	
H L Transmission delay time	t <sub>PHL</sub>	2	R <sub>L</sub> =4.7 kΩ, C <sub>L</sub> =100 pF	-	10	-	μs	

### Test Circuit 1

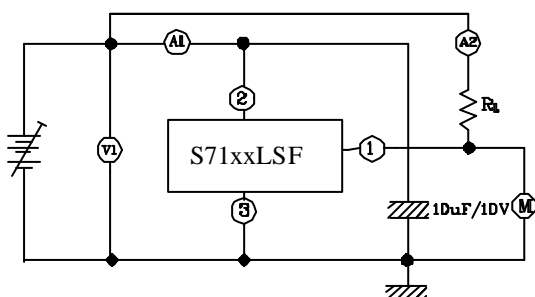

### Test Circuit 2

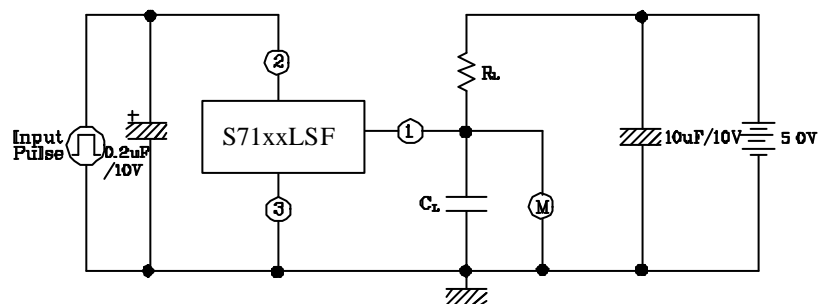

Electrical Characteristic Curves

Fig. 1  $V_O - V_{CC}$

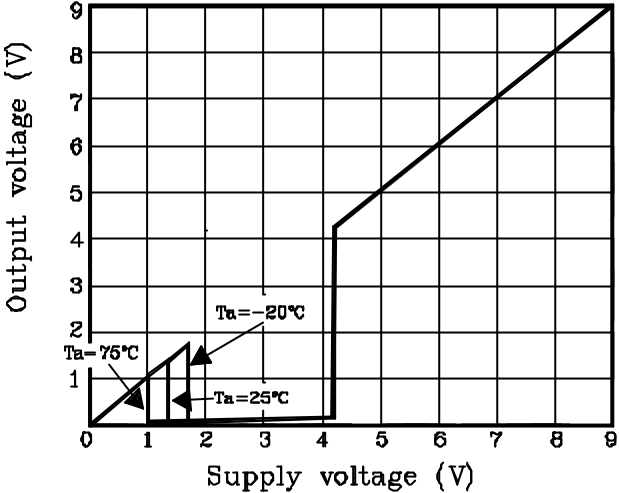

Fig. 2  $V_S - T_a$

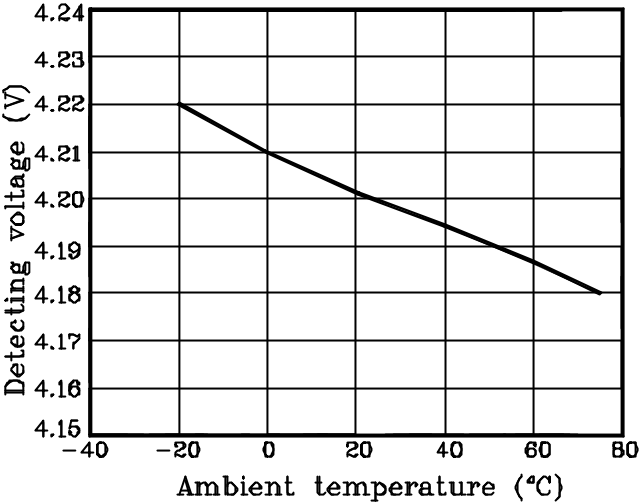

Fig. 3  $I_{CC} - V_{CC}$

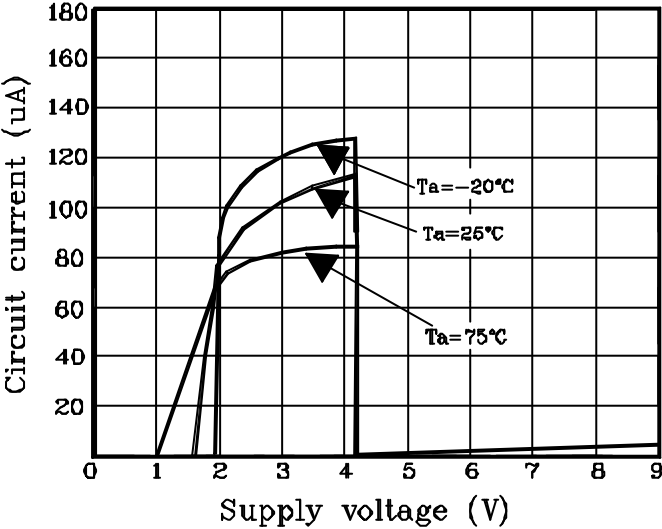

Fig. 4  $V_{OL} - T_a$

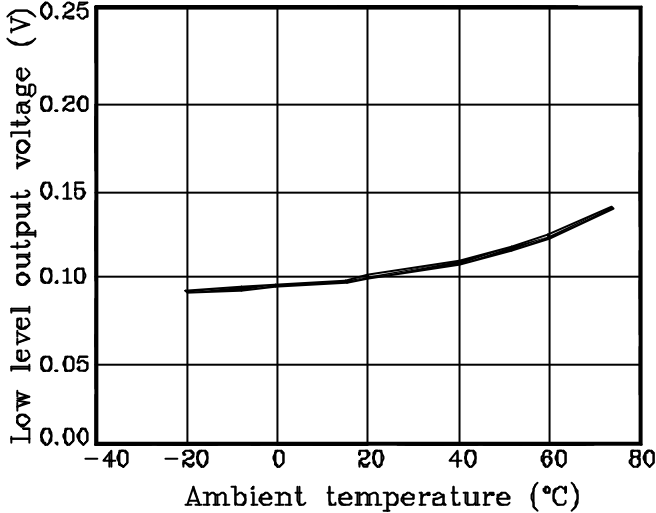

Fig. 5  $V_S - T_a$

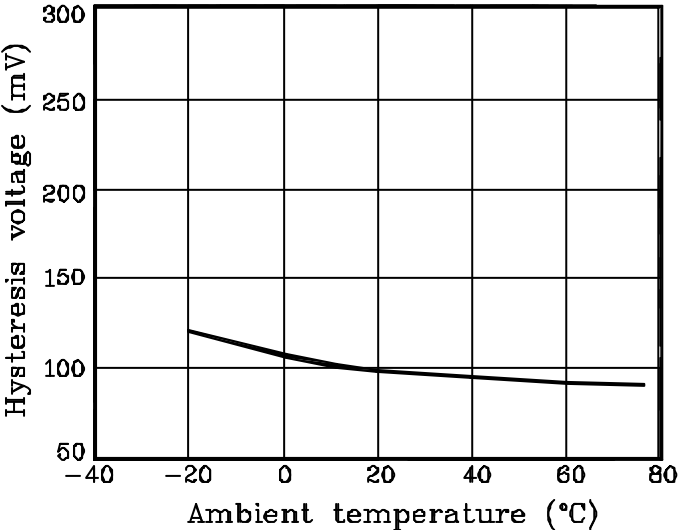

Fig. 6  $I_{CCH} - T_a$

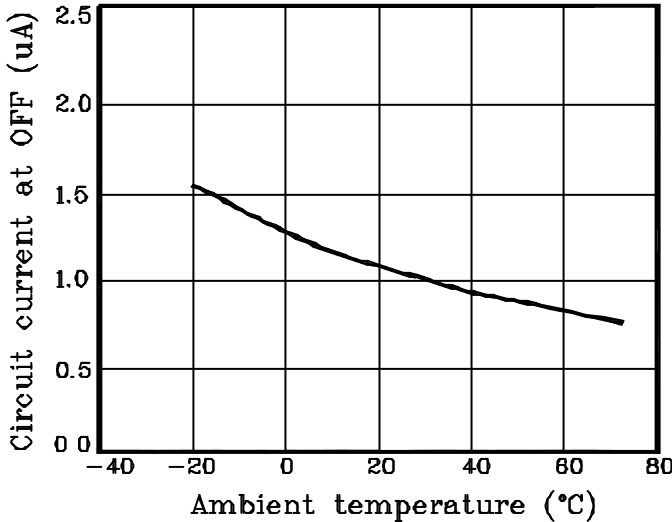

Fig. 7  $I_{OL} - T_a$

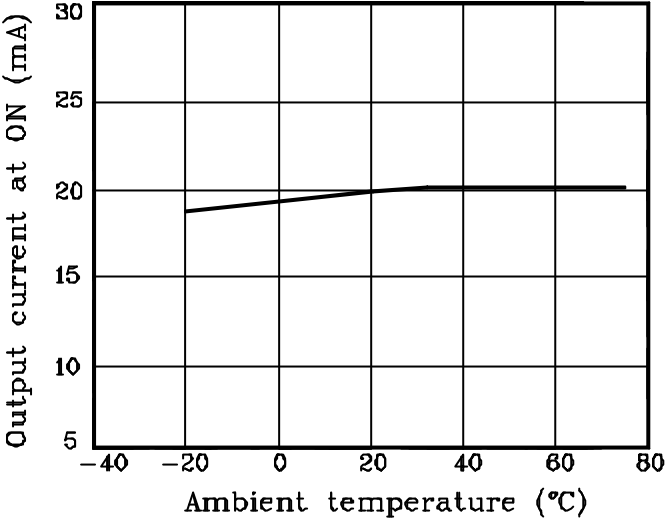

Fig. 8  $C_L - t_{PLH}$

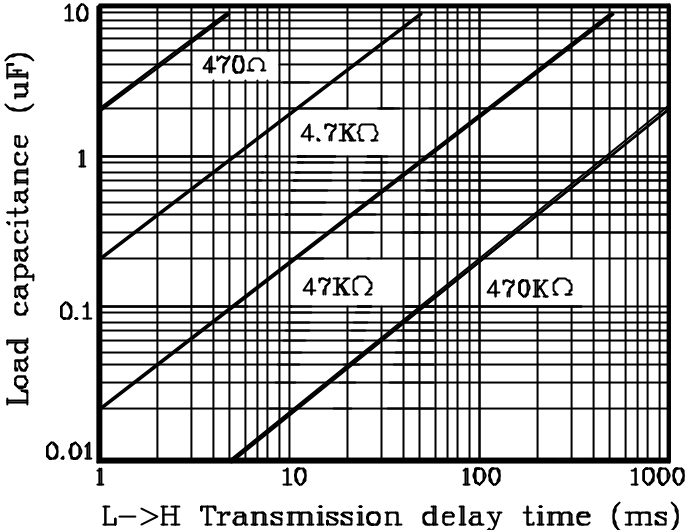

Fig. 9  $I_{CCL} - T_a$

